

Pre-Assembled Booths



Pre-Assembled Booths

Fast, Affordable Solutions

Whether you require a parking booth for your corporate facility, or a guard shelter for perimeter security, PortaFab pre-assembled booths can be specified in a variety of custom configurations to provide a fast and economical space for an unlimited number of applications.

Complete and Ready to Use

All booths are shipped fully-equipped and ready for instant use. They can be installed almost anywhere and can be easily relocated if your needs change.



The PortaFab Advantage

Long-Lasting Performance

PortaFab's rugged booths are built stronger and capable of withstanding jobsite conditions with an all-welded framework as compared to competing brands that utilize a pop-rivet design.

Unmatched Manufacturing Speeds

Just specify what you want, and booths are typically completed and shipped within weeks of purchase.

Low Maintenance & Excellent Durability

All booths come standard with tempered safety glass windows and heavy-duty steel doors for added durability. Beyond the occasional surface cleaning, there is minimal maintenance required.

Integrated Options & Accessories

Featuring a large selection of building components, we offer virtually unlimited options and combinations for various applications.



Individual color options are available to meet your requirements.



Booths can be outfitted with options like spotlights, intercoms and extra doors.

Pre-Engineered Designs

PortaFab standard booths range from 3' x 4' to 8' x 20' as one-piece units. Custom sizes are also available. Larger sizes may require a two-piece design requiring some onsite construction.



■ Swing door sizes range from 3'x6' to 8'x16'



■ Sliding door sizes range from 3'x5' to 8'x16'

Sizes for Any Application

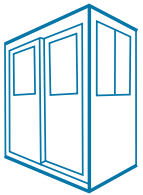

3' x 5' Sliding

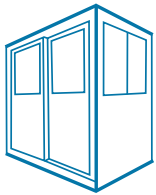

3' x 6' Sliding*

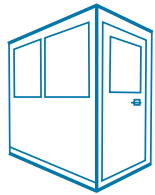

4' x 3' Swing

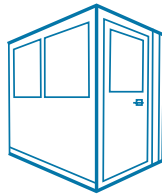

4' x 4' Swing

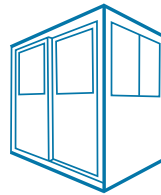

4' x 6' Sliding*

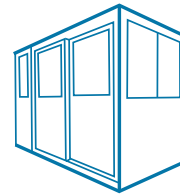

4' x 8' Sliding

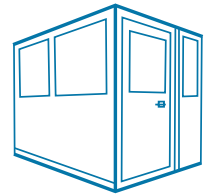

5' x 6' Swing

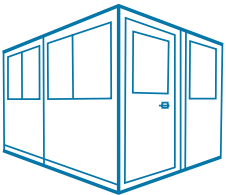

5' x 8' Swing

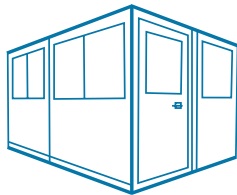

5' x 10' Swing

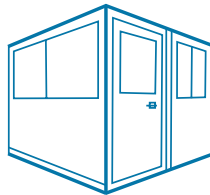

6' x 6' Swing

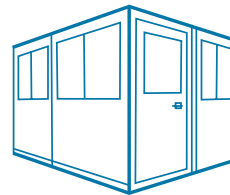

6' x 8' Swing

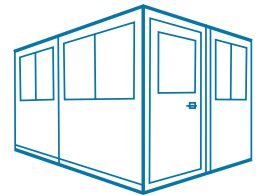

6' x 10' Swing

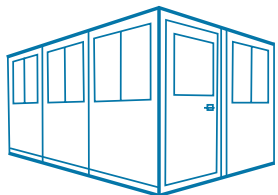

6' x 12' Swing

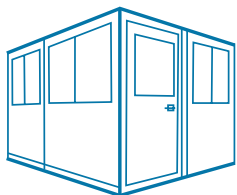

8' x 8' Swing

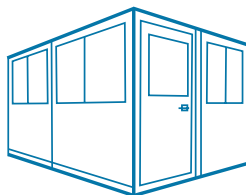

8' x 10' Swing

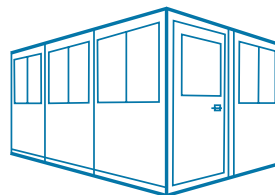

8' x 12' Swing

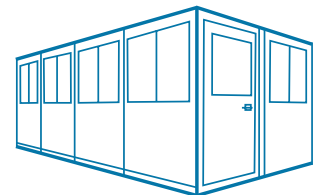

8' x 16' Swing

*Also available with a sliding door

Framework

Superior Construction

Unlike many competing brands that utilize pop-rivets or other fasteners to assemble the framework, PortaFab booths feature an all-welded aluminum framework, safety glass windows and heavy-duty steel doors that are stronger and more capable of withstanding environmental conditions at job sites.



All structural components are welded at all intersections to create a unitized framework.

Structural Benefits

- All aluminum construction eliminates rust.
- Sturdy all-welded framing ensures structural integrity.
- Unique assembly system has no exposed structural fasteners.
- Quality materials and components assure long-lasting, maintenance-free performance.

Height Options

Booths come in a standard height of 91" with an 82" interior height, but can be extended up to 108" tall.

Color Options

Each booth comes standard with the natural mill finish aluminum framework, but can be painted in other colors as a special order.



Lasting Durability

Standard wall panels are 5/8" thick and composed of a 1/2" Medex® laminated with .030" FRP (fiberglass reinforced plastic) in the pearl grey color. The Medex® board is a powerful combination of moisture resistance, superior MDF board properties, and a formaldehyde-free adhesive system.

Wall Surfaces & Colors

Textured FRP (fiberglass reinforced plastic) panels are used for the vast majority of booth applications due to their excellent durability, weatherability and low-maintenance characteristics. The standard color wall panel is pearl gray, but champagne and white are also available at no extra charge. When a more durable solution is needed for extremely harsh environments, steel and aluminum faced panels can be specified.



Standard wall panels in pearl gray



Pearl Gray



Champagne



White

Standard Wall Panel

Standard wall panels are approximately 5/8" thick and feature a 1/2" Medex® board laminated with two .030" FRP surface panels.

Textured FRP on the exterior panel surfaces

Medex® board on the inside

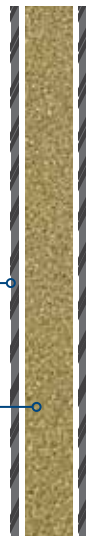

Insulated Wall Panels

The standard panels have R-3 insulation but can be upgraded to R-10 insulation. The insulated panel thickness is 1-3/4" thick and is .030" FRP over 1/8" hardboard, 1" tuff "R" polyiso board, and 1/2" Medex® board.

The ceiling panels can also be upgraded to the R-10 insulation materials.

Textured FRP on the exterior panel surfaces

Unfinished hardboard

Tuff "R" Polyiso board

Medex® board on the inside

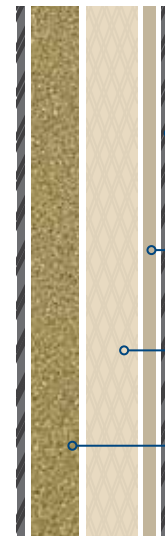

Roofing

Multiple Options

Multiple roofing options are available to accommodate outdoor and indoor environments.



Integral Roof

A factory-installed integral roof consisting of 5/8" board with vapor barrier on the exterior surface.

- 3" Overhang
- Aluminum gutters around entire building perimeter with pre-drilled hole for drainage
- Optional downspouts



Knockdown (K-D) Roof

An exterior, overhanging roof shipped "Knocked Down" to be installed on site.

- Maximum 24" overhang without support
- Larger overhangs possible with support columns
- Extruded aluminum fascia and gutter trim
- Optional downspouts

Roof Options

Tapered Roof (1/8" Over 1")

Tapered style roofs and other custom roofs and fascias are easily incorporated into a modular building design.

Indoor Roof

For booths that will only be used in an indoor environment, we offer a cost effective, integrated wood covering that serves as a basic cover for the building.

Durable & Easy to Clean

PortaFab pre-assembled buildings can be equipped with either aluminum treadplate or vinyl tile flooring.



Aluminum Treadplate

These all-aluminum panels are durable, rust-resistant and features a slip-resistant treadplate design ideal for high traffic and industrial environments.

■ Aluminum treadplate floors come standard on all buildings with 4' widths or less, but are an option for any size building.



Vinyl Flooring

This durable, yet cost-effective flooring system is suited for rugged applications and complements the three standard panel colors extremely well.

■ Vinyl flooring comes standard on all buildings that are larger than 4' wide.

Floor Construction

All buildings are mounted on 4" x 3" aluminum angle to provide added protection from the existing slab as shown below. An optional 4" x 6" electrical access panel can be cut out and installed into the building floor for utility access.

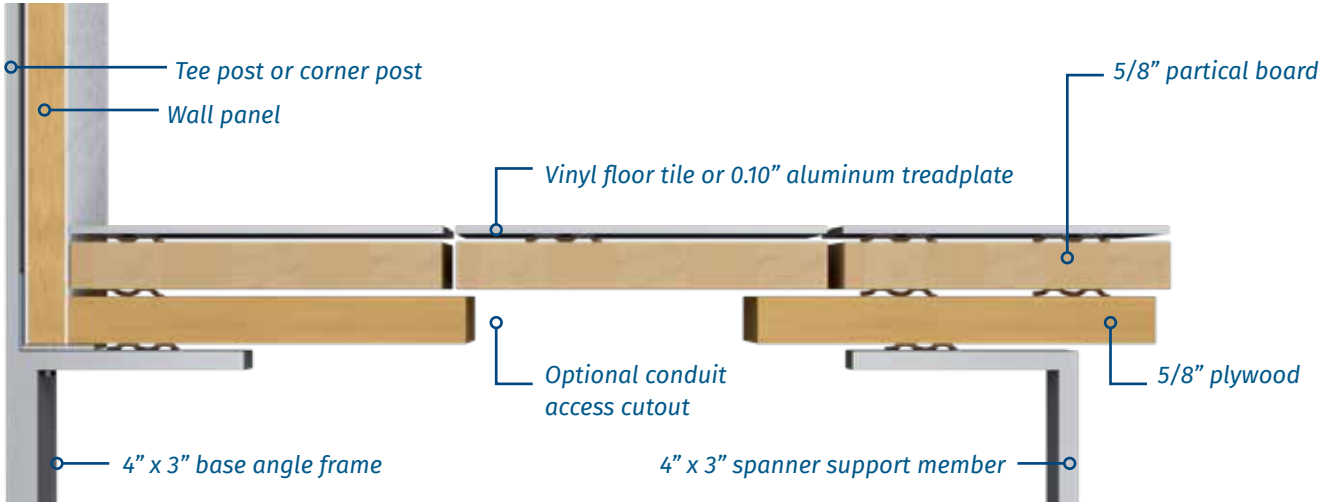

Windows

360° Viewing

PortaFab booths are outfitted with windows in every panel to ensure 360° viewing. You can choose from sliding, fixed or ticket windows in a variety of glazing options and placements.

Sliding Windows

Standard windows are heavy-duty, sliding windows that are lockable and pile weather-stripped. These allow for maximum air-flow and convenience.

- Standard glazing is 1/8" clear-tempered safety glass (see other options below)
- Standard placement is 50" from the base of the booth exterior or 44" from interior floor. Custom placement options are available.
- Window screens are also available as an option.



Fixed Windows & Solid Panels

Pre-assembled buildings can also be outfitted with fixed windows and solid wall panels. Both of these options provide an added level of security while the solid panels are ideal for booths that will be placed against a solid wall or that feature closets or bathrooms.

- Standard glazing is 1/8" clear-tempered safety glass (see other options below).
- Standard placement is 50" from the base of the booth exterior or 44" from interior floor. Custom placement options are available.



Options

Glazing Options

- 1/8" Clear-tempered safety glass
- 1/8" Tinted safety glass
- 1/8" Clear acrylic glazing
- 1/4" Tinted acrylic glazing
- 1/2" Clear insulated glass
- 1/2" Tinted insulated glass
- 1/4" Clear polycarbonate
- 1/4" Tinted polycarbonate

Ticket Windows

Booths can also be outfitted with ticket windows as shown here.



Lowered Windows

Windows can be lowered within the panel to 32" from the floor - more typical of a desk height level.

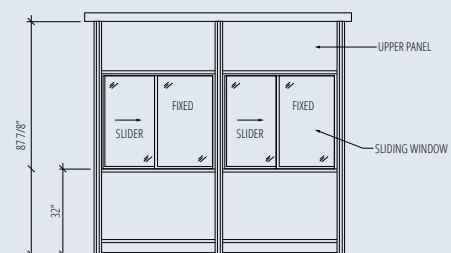

Heavy-Duty Doors

Pre-assembled buildings feature standard swing or sliding doors depending on their size, but can be outfitted with custom doors and accessorized with special locks, closers and louvers.

Swing Doors



The standard swing door measures 3' wide x 6'-8" tall x 1-3/4" thick. It is made from heavy-duty 20-gauge steel and features a 2' x 2' window, threshold and sweep.

- Aluminum frame with continuous door gasket.
- Glazed with a minimum 1/4" clear tempered safety glass.
- Commercial-quality key-in-lever lockset with spring closer
- Spring crash chain door guard

Sliding Doors

Some models feature lockable sliding doors that utilize a painted white, aluminum, weather-stripped door mounted into an aluminum frame.

- Upper portion is glazed with minimum 3/16" clear tempered safety glass
- Lower portion feature fiberglass reinforced plastic (FRP) panels to match interior and exterior surfaces.



Options

Additional Doors

Any booth with an existing swing door can be outfitted with an additional door.

Custom Doors

- Aluminum swing door
- Flush in partition full steel doors
- Full glass doors

Swing Door Accessories

- Door sweeps
- Thresholds
- Optional lever lock sets
- ADA compliant hydraulic closers
- Door louvers

Electrical & Lighting

Standard & Customizable

Each booth is outfitted with its own circuit breaker box, outlets and switched. All conduit and wiring is surface mounted and installed in compliance with the National Electrical Code using components bearing the UL label.

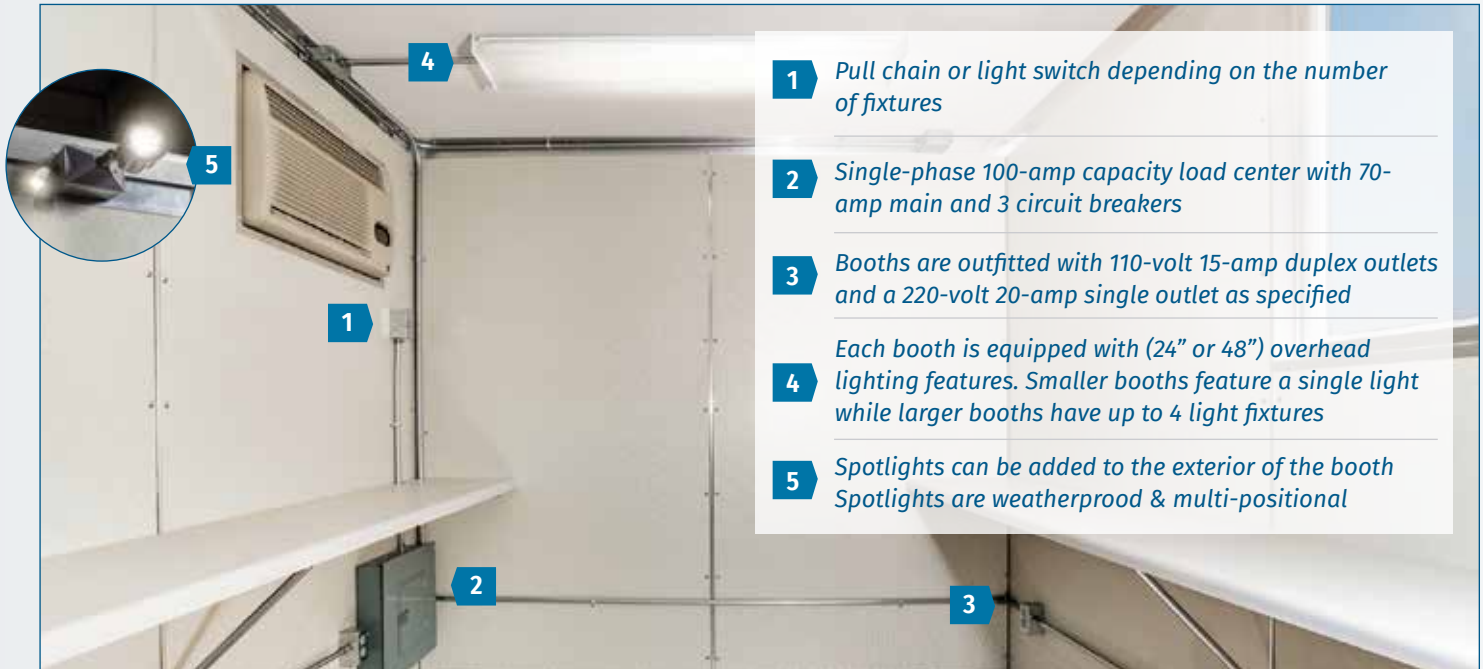

Typical Layouts

Outlets

Booths are outfitted with 110-volt 15-amp duplex outlets, 220-volt 20-amp single outlet and 15-amp switches as shown on these drawings.



Layout for toggle switch



Layout with HVAC cutout & CB box



Layout without HVAC & CB box



Layout for duplex outlets

Options

- 200 amp circuit box
- Empty conduit runs
- Extra 110 volt outlet
- GFI outlets
- Extra 220 volt outlet
- Explosion proof electrical

Explosion proof electrical systems for hazardous locations.



Year-Round Comfort

A variety of air conditioning and HVAC options can be added to regulate temperatures within the booth.



When an AC/HVAC unit is specified, the building is outfitted with a custom-fit wall cutout to accommodate the unit. The unit ships with the booth so it can be installed and running immediately.

Optional Components

1 Insulated Walls

Insulated wall panels can provide additional protection from extreme temperatures.

2 HVAC & AC Units

PortaFab booths can be outfitted with a number of standard air conditioner and HVAC units. Wall mount AC units include: 8000 BTU–115V, 12,000 BTU–115V and 15,000 BTU–230V. AC and heater combo include 8,000, 11,000 and 15,000.

3 Exhaust Fans

Integrated exhaust fans provide a cost-effective method of circulating airflow and improving worker comfort.

4 Baseboard Heaters

Electric baseboard heaters can be surface mounted onto walls and integrated with the building's electrical system.

Walls & Shelves

Interior Convenience

From outfitting small parking attendant booths with shelves and cash drawers to developing pre-assembled buildings complete with bathrooms or offices, our engineering team can work with you to provide the interior elements you require.

Common Applications

- Bathroom
- Storage Closet
- Interior Office

■ *The construction of a bathroom typically includes the addition of an interior chase wall to house the plumbing.*



Shelving

Interior Shelf

An interior shelf is 16" deep and ships installed. The shelf is a gray high pressure laminate. Units up to 48" wide come with the shelf as a standard. A metal storage drawer or cash drawer can be installed under the shelf if required.



Exterior Shelf

Shelving can be added to one or multiple sides of a building for customer convenience. Exterior shelves can be added to the product in the accessories area while ordering a quote.



Drawer Options

Metal Storage Drawer

A very common accessory added to booths, metal storage drawers can be added to any of PortaFab's standard booth sizes.



These drawers have the option of being equipped for cash transactions with a money shelf inside the drawer or the locking drawer can be used for non cash storage as well.

Thru Wall Transaction Drawer

The thru wall transaction drawer features a medium sized transaction drawer in order to enable cash transactions or transfer of products.



The steel drawer opens and closes from the inside in order to create a secure transfer for the attendant within the booth. Transaction drawers are outfitted underneath a window on a panel wall of a booth.

Forklift & Crane Options

For booths that will need to be moved on a regular or semi-regular basis, we offer options to accommodate both forklifts and cranes.



Lifting Rings

Lifting or hoist rings can be integrated into a booth to allow for overhead lifting by a crane. Eyelets are mounted through structural angle designed to give the booth added structural support.

Forklift Pockets

All booths are built using 4" tall angle frame that can have slots installed to accommodate the forks of a standard lift truck. Depending on the building size, fork extensions may be required to safely transport the booth.



Delivery & Shipping

Depending on the size and roofing option chosen, most booths are shipped fully assembled and ready for immediate occupancy.

- Most booths are shipped via flatbed truck
- All buildings will ship with 2 x 4 support boards underneath the building to assist with off-loading with a forklift
- Booths can also be off-loaded with crane, but require a spreader bar to prevent damage

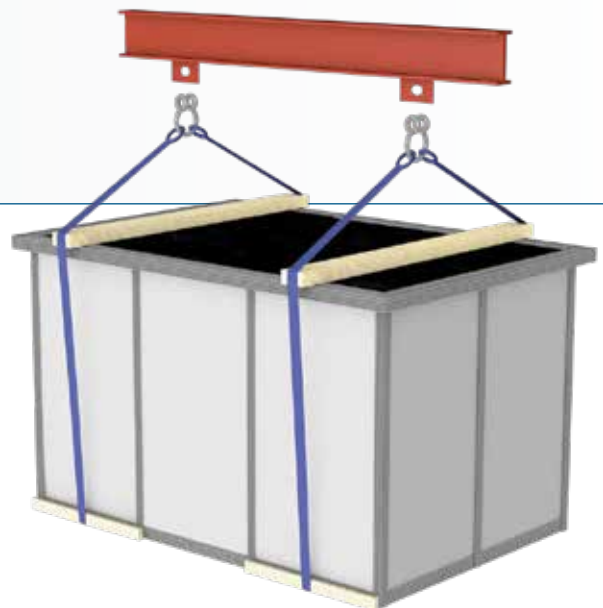

Application Gallery



Airport Security Booth



Parking Lot Attendant Booth



Security Guard Booth



Booth with Swing Door and Partial Roof Overhang



360° View Guard Booth



Guard Booth with Forklift Pockets

Application Gallery

Valet Booth with Sliding Doors



Booth on Elevated Pad



Booth with Overhang Roof



360° View Guard Booth with Overhang Roof



4'x3' Booth with Swing Door & Forklift Pockets



Mezzanine Mounted Booth



Application Gallery

Booth with Interior Bathroom/Closet



3'x5' Parking Lot Attendant Booth with Tinted Windows



3'x5' Parking Garage Booth with Sliding Door



Security Guard Booth



Ticket Booth with Roof Overhang at Sports Complex

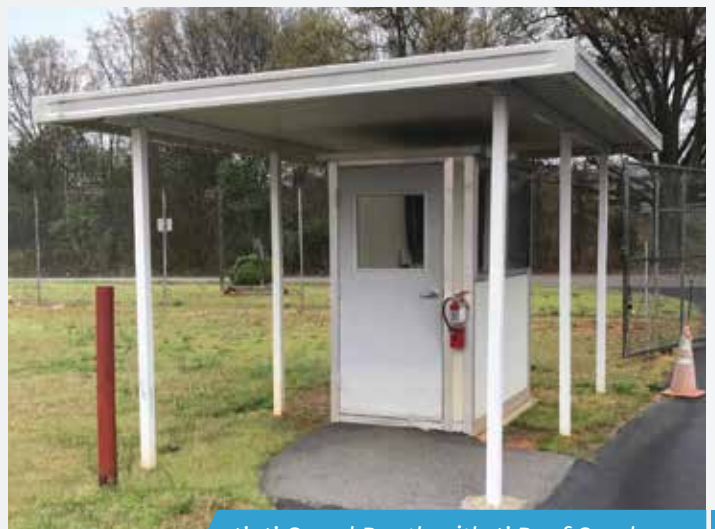

4'x4' Guard Booth with 4' Roof Overhang

Unique Applications

Indoor Cooling Booths



Modular Equipment Enclosure



Specifications

Section 1 General

1.01 Section Includes:

- A. A. This Section specifies all requirements necessary to furnish and install a prefabricated portable aluminum building(s) including, but not limited to the following:
1. Frameworks.
 2. Windows.
 3. Door.
 4. Roof.
 5. Hold down clips.

1.02 Related Sections:

- A. This Section shall be used in conjunction with the following other specifications and related Contract Documents to establish to establish the total requirements for the referenced prefabricated building:
1. The Subcontract.
 2. Electrical service supply and connection.
 3. Site/Foundation work.
 4. Unloading, placement, installation and anchoring.
 5. Plumbing and piping (when required).

1.03 References:

- A. Refer to *Porta-Fab Preassembled Building Website* for technical data, design requirements and additional information.

1.04 Submittals:

- A. Submit the following in addition to the standard requirements.
1. Upon award of order, manufacturer shall prepare and submit copies of shop drawings as required for each different building required for this project. Drawings shall include elevations, section, floor plan, and anchor clip detail.
 2. Color charts illustrating available colors and patterns for specified finishes shall be submitted to owner for prompt selections.

1.05 Quality Assurance:

- A. Manufacturer.
1. Structures shall be the product of a manufacturer with a minimum of 25 years-documented experience in the design and fabrication of portable aluminum buildings.
 2. Prefabricated buildings by manufacturers other than the one approved shall submit sufficient data to enable approval to be given. As a minimum: Design drawings and /or calculations, applicable certifications, catalog information, and color samples showing equal range of variety.
 3. Electrical devices factory installed within the prefabricated building shall be UL listed. Factory installed wiring system shall bear UL Classification insignia certifying compliance with the National Electrical Code, 2000 edition.

4. Adherence to applicable portions of state and local building codes is the responsibility of the owner. Building manufacturer shall not be responsible for permits, special engineering calculations or architectural type drawings unless otherwise notified in writing 3-weeks prior to release of bid document.
5. Design Loads: 30 lbs/ft² live load, 20 lbs/ft² wind load, 40 lbs/ft² floor load.

1.06 Warranty:

- A. Porta-Fab Preassembled Buildings are warranted against defects and workmanship for a period of one (1) year from date of original shipment. Porta-Fab is not responsible for or liable for modifications, alterations, misapplication or repairs made to the products in the field.

1.07 Technical Services:

- A. Porta-Fab Corporation offers technical service support. For services regarding layout, design and product selection, as well as suggested specifications, contact the main office (Section 2.02).

Section 2 Products

2.01 Product Name:

- A. Preassembled Buildings

2.02 Manufacturer:

- A. Porta-Fab Corporation
18080 Chesterfield Airport Road
Chesterfield, MO 63005 U.S.A.
Phone: (636) 537-5555
Fax: (636) 537-2955

2.03 Product Description:

Basic Uses: Provide a pre-assembled for the following typical uses: Equipment enclosure, gate house, gas station booth, guard booth, observation tower, operator booth, parking booth, press box, security booth, ticket booth, toll booth, and valet booth:

- A. Structural members to be extruded aluminum angles, channels, and tee sections of structural alloy 6063-T5 alloy. Base to be 4" x 3 x 3/16" angle (4" structural channel used on buildings larger than 8' x 12', and two piece buildings); corner posts to be 3" x 3" x 3/8" grooved angle; grooved intermediate tees to be 3" x 2 1/8" x 3/8"; top angle to be 2 1/2" x 2 1/2" x 3/16".
- B. All structural components to be certified welded at all intersections to create a unitized framework. No rivets, bolts or other fasteners shall be used in joining structural components.
- C. Finish – Framework:
 1. Mill-finished aluminum.
 - a. (Option) Provide painted exterior framework.
- D. Wall and Ceiling Panels:
 1. Wall panels shall be 1/2" Medex™ laminated on both sides with .030" FRP (fiberglass reinforced plastic). Panels shall be attached to the structural members with fasteners not exposed on the building exterior. Ceiling panels shall be minimum 5/8" white vinyl-faced particle board.
 - a. (Option) Provide R-10 wall and ceiling insulation.

E. Flooring:

1. Floor structure to consist of one layer of 5/8" particle board and one layer of 5/8" plywood underlayment as the core with a vapor barrier on the exterior surface. Interior surface shall be aluminum tread plate, 0.10" thick, Tread Brite model #3003 on buildings up to and including 48" wide. All larger buildings shall have a 12" x 12" vinyl tile, manufacturer is Azrock model #V-312, White Tracery.
 - a. (Option) Provide R-10 floor insulation.

F. Doors:

1. Swing doors to be of 3068 20-gauge steel, 1 3/4" thick with threshold and 2' x 2' window with minimum 1/4" clear tempered safety glass. Hardware to include: 1 1/2 pair of 4 1/2" x 4 1/2" butt hinges; commercial quality, lever lockset; spring closer and continuous vinyl gasket on door frame.
2. Sliding Doors to be aluminum, painted white, fully weather-stripped and lockable. Upper portion to be glazed with minimum 3/16" clear tempered safety glass and lower portion to have a solid panel with matching interior and exterior surfaces.

G. Windows and Glazing:

1. Windows shall have aluminum frames and inserts and to be industrial quality with active window panel to slide horizontally. Windows to include inside positive locking device. Exterior window sill height to be 50" (inside sill height 44" from finished floor).
 - a. (Option) Fixed windows to be 1/4" tinted tempered safety glass.
2. Windows to be glazed with minimum 1/8" clear tempered safety glass.
 - a. (Option) Windows to be 1/4" tinted tempered safety glass.
 - b. (Option) Windows to be 1/2" clear insulated tempered safety glass.
 - c. (Option) Windows to be 1/2" tinted insulated tempered safety glass.

H. Shelf:

1. Furnish 16" deep, full-width shelf, per plans, 42" a.f.f. and finished with a HPL high pressure laminate) on all buildings up to 48" in width.
 - a. (Option) Provide a steel storage drawer, with lock.
 - b. (Option) Provide a lockable Indiana R-1 cash drawer, with trays.

I. Electrical:

1. Electrical service to include a single-phase 100-amp capacity load center, with 70-amp main and three circuit breakers; fluorescent lighting; 110-volt 20 amp duplex outlets; 220-volt 20 amp single outlet and 20 amp switches as shown on drawings. All conduit and wiring shall be surface mounted and installed in compliance with the National Electrical Code. Conduit is 1/2" emt cable and wire is #14. All electrical components shall bear the UL label
2. Furnish () 115v duplex outlet, and one 230v single outlet.

3. Lights to be fluorescent type fixture with acrylic lens.

- a. (Option) Include HVAC unit (230v, 12,000c / 10,700h BTU).
- b. (Option) Include air conditioner (120V, 8,250c BTU).
- c. (Option) Include one heater unit (230v, 4000w).
- d. (Option) Include () additional duplex 115v outlets.
- e. (Option) Include () empty conduit runs with pull wire to run communication lines.

J. Exterior Roof:

1. Factory installed integral roof to consist of 5/8" plywood with vapor barrier on the exterior surface. Buildings larger than 4' x 8' to receive two layers of 5/8" plywood. Roofs to include aluminum gutters around the entire perimeter.
 - a. (Option) "K-D" exterior waterproof roof shipped for assembly and installation on site by others. Decking to be standing seam formed, pre-finished white aluminum, nominal 12" wide panel, .028" thick. Roofs with overhangs larger than 12" to have reinforcing angles included. Perimeter to be extruded aluminum fascia and gutter trim.

Section 3 Execution

3.01 Installation:

- A. General: All preparatory work and installation work shall be performed by site-contractor and shall be performed in accordance with local and/or state codes.
- B. Pour concrete island minimum 4" deep. The island should be a minimum of 12" wider than the roofline dimensions to allow a 6" concrete border on each side of the building roofline. Level the pad and install a bollard at each corner of the building to further protect the building from damage caused by traffic.
- C. Provide 3-wire 240v/110v single-phase service to the concrete island. Coordinate stub-up location with prefabricated building layout plans.
- D. Building to arrive via flatbed truck or closed van. The carrier must contact end-user 24-hours prior to delivery to arrange for off-loading. Use either a forklift or overhead crane to off-load the building from the flatbed. If an overhead crane is used, be sure to use "spreader bars" to prevent the building fascia/roof from being damaged by the sling/straps. Square the building on the pad and anchor.
- E. Recommended concrete anchor is 1/2" x 4" galvanized or stainless steel, or comply with local codes - whichever is most stringent. Anchors are provided by site-contractor.
- F. Make final electrical connections and clean the work area.

Additional Modular Construction Capabilities

Applications & Ideas



Painting and Finishing Systems



Modular Architectural Cleanroom Systems



Modular Offices & Implant Buildings